

Scope

This specification applies to built-in DC stabilized power supply, mUZP-150-**-**E*-.
 In addition, all items in this specification shall be provided at nominal temperature and humidity unless otherwise specified.

Model Name Coding

Example: mUZ P - 150 - 24 - J 0 E □ - C
 ① ② ③ ④ ⑤ ⑥ ⑦ ⑧ ⑨

- ① Series Name..... "mUZ": mUZ series
- ② Peak power..... "P": Corresponding to Peak power
- ③ Continuous output power..... "150": 150W
- ④ Output voltage..... "12": 12V, "18": 18V, "24": 24V, "48": 48V
- ⑤ Input/Output connector type..... "J": Nylon connector, "T": Block terminal (2 terminal, without FG)
- ⑥ Backup Function..... "0": without Backup Function
- ⑦ Low standby power..... "E": Low standby power type (at remote OFF)
- ⑧ Modification..... "Blank": Standard, "1~9" or "A~Z": Modification symbol
- ⑨ Chassis..... "C": With chassis, "K": With Chassis and Cover, "Blank": Without Chassis and Cover



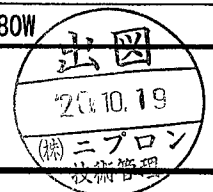

General Specification

Items		Specification				Measurements conditions, etc.	
		mUZP-150-					
		12	18	24	48		
AC Input	Rated Voltage	100-240VAC				Worldwide range	
	Voltage Range	85-264VAC				Load factor shall be 95-100% in range of 85-90VAC input	
	Current	At 100VAC	1.7A typ		At rated output (Natural air cooling)		
			2.9A typ	3.1A typ		At rated output (Forced air cooling)	
		At 200VAC	0.9A typ		At rated output (Natural air cooling)		
			1.5A typ	1.6A typ		At rated output (Forced air cooling)	
	Rated Frequency	50/60 Hz				Frequency range 47-63Hz	
	Inrush Current	At 100VAC	17A typ				Power thermistor system At cold start (25°C)
		At 200VAC	34A typ				
	Efficiency	At 100VAC	88.0% typ		88.5% typ		At rated output (Natural air cooling)
		At 200VAC	91.0% typ		91.5% typ		
	Power Factor	At 100VAC	99% typ				At rated output (Natural air cooling)
		At 200VAC	90% typ				
	Standby Power	At 100VAC	0.03W typ				Power consumption at RC signal OFF
At 240VAC		0.20W typ					
Input Voltage Momentary Fluctuation	70VAC/500msec		at load 180W				
	40VAC/100msec		at load 180W				

Note:



Drawn by	Yodo	Checked by	Yamada	Approved by	Yamamoto	Model: mUZP-150-**-**E*	Drawing No. 3382-01-4-520 1/10
----------	------	------------	--------	-------------	----------	----------------------------	--------------------------------------

Items		Specification				Measurements conditions, etc.
		mUZP-150-				
		12	18	24	48	
Environment	Operating Temp.	Natural Air Cooling	-10 to 70°C (Open frame)			Refer to "Output derating specification"
			-10 to 60°C (With chassis and cover)			
	Forced Air Cooling	-10 to 70°C (Open frame)			Refer to "Output derating specification" *1	
		-10 to 70°C (With chassis and cover)				
	Operating Humidity	20 to 90%RH				
	Storage Temp./Humidity	-20 to 85°C/10 to 95%RH				There shall be no condensation
Vibration	To endure the vibration acceleration of 2G with vibration frequency of 10 to 55Hz for 10 sweep cycles in each X, Y, Z direction.				Follow JIS-C-60068-2-6 At no operation	
Mechanical Shock	Left one bottom edge of the unit 50mm high with the opposite edge placed on the test bench, and let it fall. Repeat 3times for each of four bottom edges, and no malfunction shall be observed.				Follow JIS-C-60068-2-31 At no operation	
Insulation	Dielectric Strength	4kVAC/1minute between input and output/RC				Cut-off current 10mA
		3kVAC/1minute between input and FG				Cut-off current 10mA
		500VAC/1minute between each output/RC/FG				Cut-off current 100mA
	Insulation Resistance	50MΩmin. between each input/output/RC/FG				At 500VDC
Leakage Current	0.06mA typ (At 100VAC), 0.12mA typ (At 200VAC)					
Others	Electrostatic Discharge	IEC61000-4-2 test level 3 compliant (Contact discharge ±6kV, 10 times)				Apply to FG and case. There shall be no malfunction, nor failure.
	Line Noise Immunity	± 2000V (pulse width of 100/1000ns, cycle period of 30 to 100Hz, Normal/Common mode with Positive/Negative polarity for 10 minutes)				To be measured with INS-410. There shall be no fluctuation of DC output or malfunction.
	Impulse Voltage Immunity	IEC-61000-4-5 (Installation environment) compliant; apply 5 times each of Common mode ±4kV and Normal mode ±2kV				There shall be no malfunction, nor failure.
	Conducted Emmission	VCCI, FCC, CISPR22, and EN55022 ClassB compliant				Rated input and rated output (Natural air cooling) With chassis
	Harmonic Current Regulations	IEC61000-3-2 (edition 2.1) class D, EN61000-3-2 (A14) class D compliant.				At rated input and continuous rated output
	Safety Standard	UL60601-1, CSA C22.2 No. 601.1 (c-UL), ANSI/AAMI ES60601-1				IEC60601-1 2 nd and 3 rd (MOPP)
		CCC (GB4943.1 Standard) 				Product can not be safely used over 2,000 meters altitude. 
		CE marking (IEC62368-1) 				
	Cooling system	Natural air cooling				PSE (Ordinance item 2) compliant
	Dimensions and Weight	75mm × 32mm × 160mm (W × H × D) / 300g typ				Without Chassis and Cover
83.8mm × 45mm × 188mm (W × H × D) / 520g typ				With Chassis and Cover		
Warranty	Three years after delivery: if any defects belong to us, the defective unit shall be repaired or replaced at our cost.				Except for errors caused by operation not specified in this specification 	

Note *1. Derating is required for operating at 0°C or lower.
Derating rates are 85VAC: 80%, 90VAC: 86.7%, 100VAC: 100%

2010.10
A×3 2020.03.26 Nakagawa

Drawn by	Yodo	Checked by	Yamada	Approved by	Yamamoto	Model:	mUZP-150-**-**E*	Drawing No.	3 3 8 2 - 0 1 - 4 - 5 2 0 A
									2 / 10

Output Specification							
Items		Specification				Measurement conditions, etc	
		mUZP-150-					
		12	18	24	48		
Output Rating	Rated Voltage		12V	18V	24V	48V	At rated input. Refer to "Output derating specification"
	Continuous Rated Output1 (Natural air cooling)	Current	12.5A	8.4A	6.3A	3.2A	
		Power	150W	151.2W	151.2W	153.6W	
	Continuous Rated Output2 (Forced air cooling)	Current	21A	14A	11.3A	5.7A	
		Power	252W	252W	271.2W	273.6W	
	Peak Rated Output (10s Max.)	Current	33.4A	22.3A	16.7A	8.4A Δ	
Power		400.8W	401.4W	400.8W	403.2W		
Output Characteristics	Factory Setting		12V \pm 2%	18V \pm 2%	24V \pm 2%	48V \pm 2%	At continuous rated output1
	Adjustable Voltage Range		12V - 5%, +10%	18V - 5%, +10%	24V - 5%, +20%	48V - 5%, +10%	
	Static Input Regulation		48mV Max.	72mV Max.	94mV Max.	192mV Max.	
	Static Load Regulation		100mV Max.	125mV Max.	150mV Max.	300mV Max.	
	Temperature Regulation		0.02%/°C max.				
	Ripple Voltage	0 to +70°C	120mVp-p Max.			150mV Max.	Connect 150mm max. lead wire to output connectors, and then connect a 10 μ F electrolytic capacitor with a 0.1 μ F ceramic capacitor in parallel to the other ends of the wires to measure by an oscilloscope with 100MHz frequency band.
		-10 to 0°C	160mVp-p Max.			200mV Max.	
	Spike Voltage	0 to +70°C	150mVp-p Max.			250mV Max.	
-10 to 0°C		180mVp-p Max.			400mV Max.		
Protection Circuit	Over Current Protection	OCP point	101%min. of peak rated current				
		Method	blocking oscillation				
		Recovery	Automatic recovery				
	Over Voltage Protection	OVP point	13.8 ~ 16.2V	22.0 ~ 26.0V	30.0 ~ 35.0V	56.2 ~ 63.0V	
		Method	Output shutdown (latch lock)				
Recovery	Reclosing of AC input						
Note:							



A×1:2020.04.24 Nakagawa

Drawn by	Yodo	Checked by	Yamada	Approved by	Yamamoto	Model:	mUZP-150-**-**E*	Drawing No.	3382-01-4-520A
									3/10

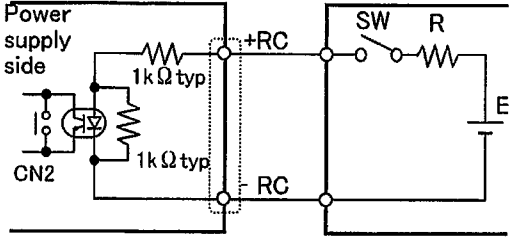
Signal Input/Output Specification					
Items	Specification				Signal circuit
	mUZP-150-				
	12	18	24	48	
Input Signal	Output ON/OFF control signal (RC signal)	<u>Operating mode</u>		<u>Connecting example in the case of using external power supply</u> 	
		Between +RC and -RC	CH1		
		SW ON (4.5V min.)	ON		
SW OFF (0.8V max.)	OFF				
<u>External power supply and Load-limiting resistor</u>		External power supply : E	Load-limiting resistor : R		
		4.5-12.5Vdc	Not required		
		12.5-30Vdc	1.5kΩ		
		30-48Vdc	8.2kΩ		
<u>Shorting Plug</u>		With shorting plug (CN2) connected, output starts up when AC input is applied regardless of RC signal.			
		To control Start/Stop of output by RC signal, uncap shorting plug of CN2.			
<u>Note:</u>		Shorting plug (CN2) is primary circuit components. Make sure to operate the plug after the AC input is turned off.			
Note					



Drawn by	Yodo	Checked by	Yamada	Approved by	Yamamoto	Model: mUZP-150-**-**E*	Drawing No. 3382-01-4-520 4/10
----------	------	------------	--------	-------------	----------	----------------------------	--------------------------------------

● Sequence Timing Diagram

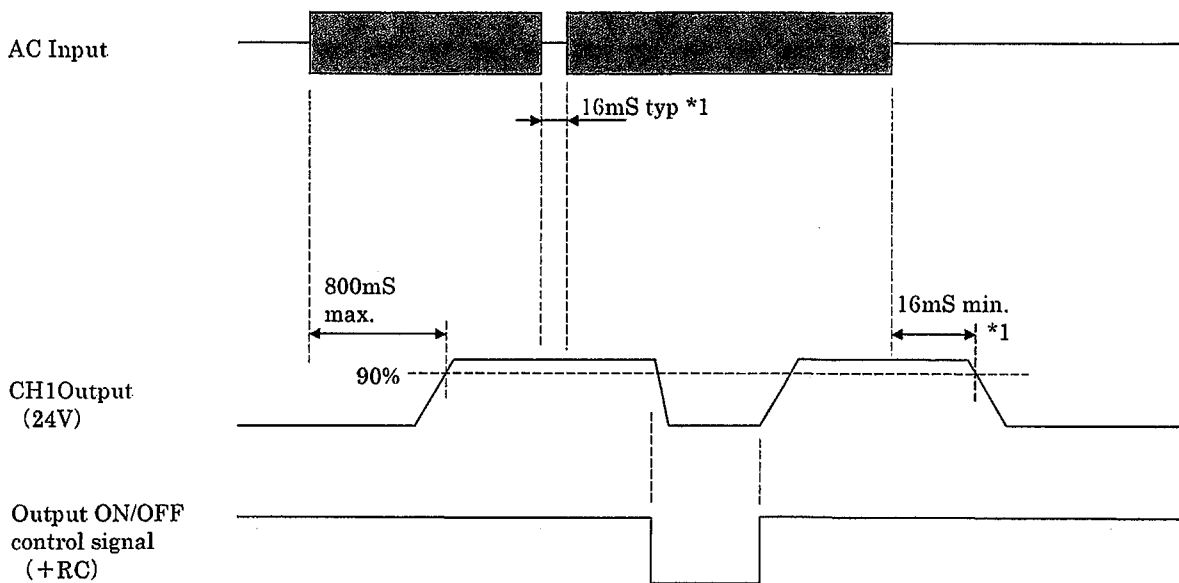

*1 Rated input, 150W output

● Peak Output Specification

Peak output current shall meet the conditions below.

- Duty ratio of peak current shall be 30% or less.
- Energized period of peak current shall be 10 seconds or less.
- In the case that the ambient temperature is 50°C or higher with natural air cooling, the energized period of peak current shall be 5 seconds or less.
- The value resulting from the formula below shall not exceed the continuous rated current, I_o , after derating specified in "Output derating" item.

$$\sqrt{((I_p^2 \times D) + (I_m^2 \times (1-D)))} \leq I_o$$

I_p = Peak current value

I_m = Min. current value

D = Duty ratio, t/T

t = Pulse width of peak current

T = Cycle

I_o = Continuous rated current specified in "Output derating" item

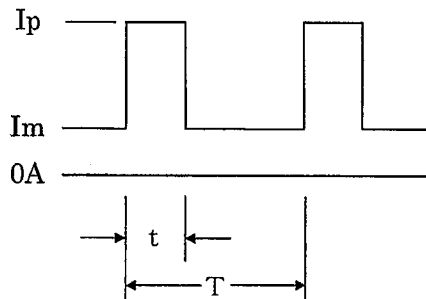

(Note)

In case that temp. of power thermistor for prevention of inrush current does NOT go up enough (Resistance value is high), such as the amount of average load power is small, output power at peak power might drop for about 100ms. If this might cause any problem, please check output voltage waveform equipment and operating the power supply with actual device.

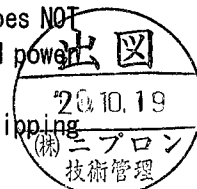

Drawn by	Yodo	Checked by	Yamada	Approved by	Yamamoto	Model:	Drawing No.
						mUZP-150-**-**E*	3382-01-4-520 5/10

**Output Derating Based on Ambient Temperature,
Installation Direction and Cooling Condition**

Follow the derating diagram below for output according to the ambient temperature and installation direction.

In case of using the type with chassis and cover, input voltage range shall be 90VAC or higher, and shall not use in direction (f). Also, forced air cooling condition in the diagram shall be provided that the air flow of 1.5m/s is applied from the direction shown below.

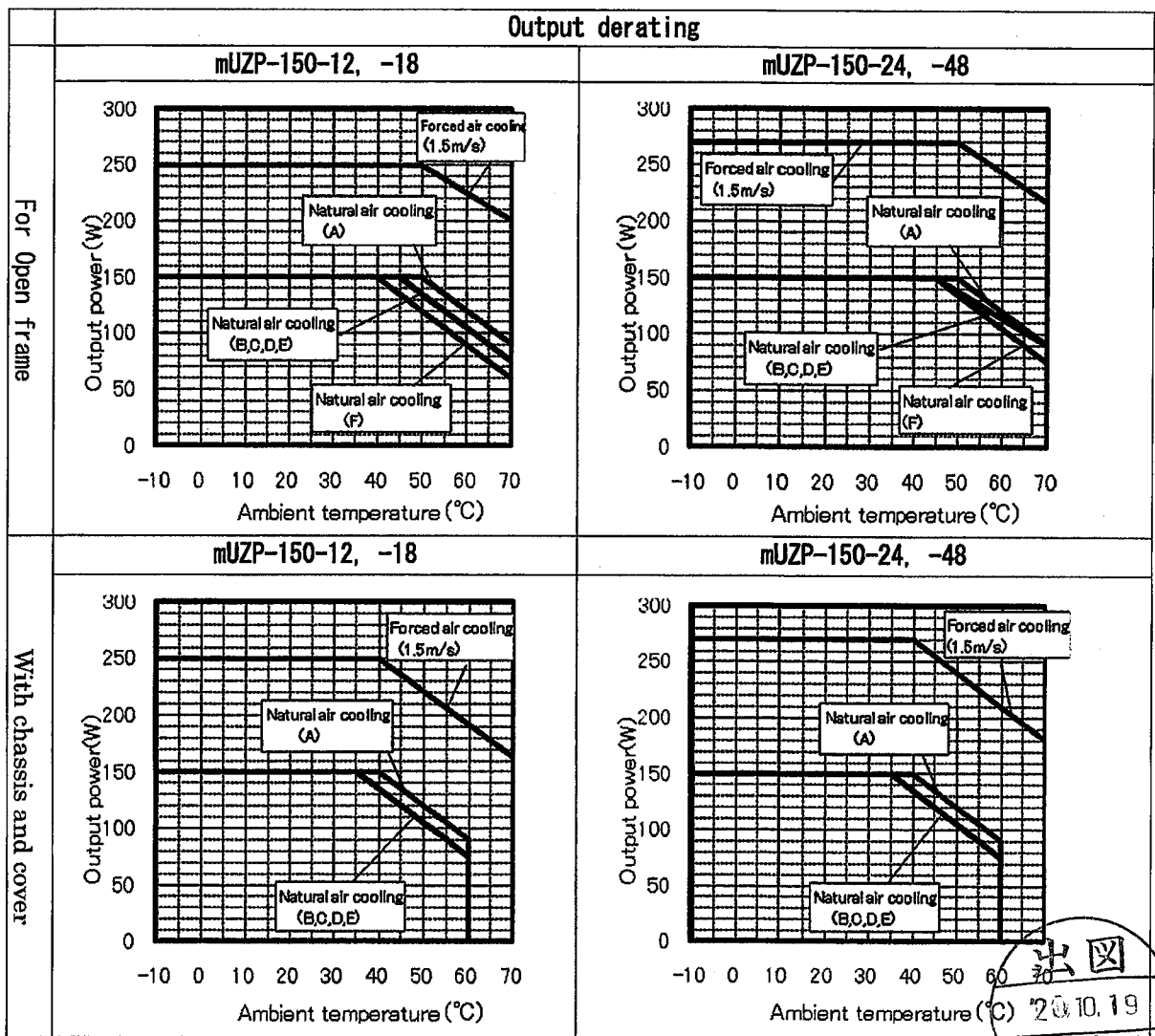
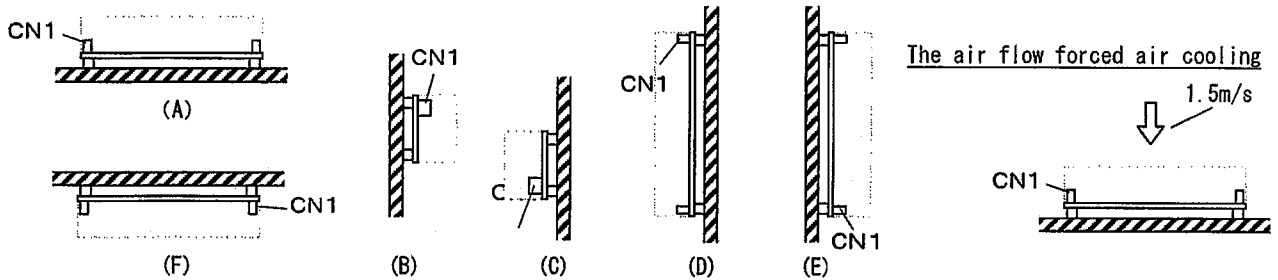

出図
2010.19
技術管理

Drawn by <i>Yodo</i>	Checked by <i>Yamada</i>	Approved by <i>Yamamoto</i>	Model: mUZP-150-**-**E*	Drawing No. 3 3 8 2 - 0 1 - 4 - 5 2 0
				6/10

●Guideline for forced air cooling

Ask us separately about the guideline for temperature rise of each component at forced air cooling.

●Output Derating vs. Input Voltage

When input voltage is 90VAC or lower, follow the derating diagram below to reduce the continuous rated current and power.

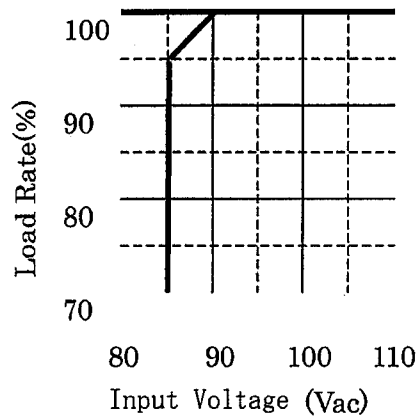

Note



Drawn by	Yodo	Checked by	Yamada	Approved by	Yamamoto	Model: mUZP-150-**-**E*	Drawing No. 3382-01-4-520 7/10
----------	------	------------	--------	-------------	----------	----------------------------	--------------------------------------

● Circuit Block Diagram

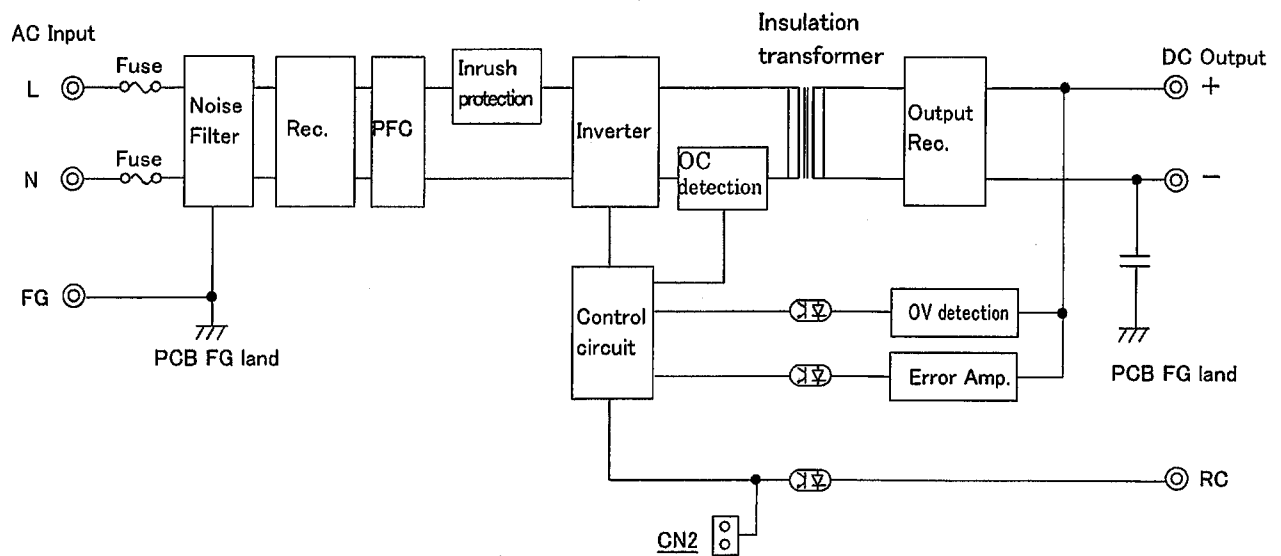

Note



Drawn by	Yodo	Checked by	Yamada	Approved by	Yamamoto	Model: mUZP-150-**-**E*	Drawing No. 3382-01-4-520 8/10
----------	------	------------	--------	-------------	----------	----------------------------	--------------------------------------

Nipron Co.,Ltd.

Due to the technical improvement, the specifications and functions are subject to change without notice.

●Power Supply Installation

- To meet the standard of insulation and dielectric withstanding, install the power supply to keep the dimensions, d1, d2, and d3, shown in the drawings below.
- Install the power supply so that natural air convection and air ventilation are expected to keep the temperature rise around the power supply low.

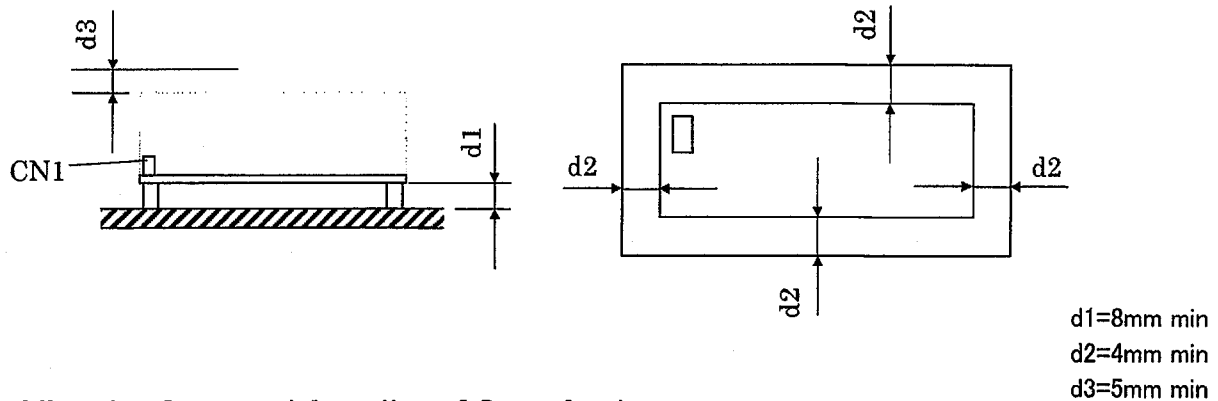

●Mounting Screws and Grounding of Power Supply

- Fix all 4 screws firmly at power supply mounting holes.
- Use 3mm diameter screws for mounting power supply.
- Do not use the metal mounting parts that exceed the hatched area shown below.
- In mounting the unit with Chassis and Cover, do not use any screws that exceed the area shown below.
- Make sure to connect FG terminal of CN1 (Nylon connector) or FG on the soldered side of PCB or heatsink with mounting holes, chassis to customer's safety grounding. However, the connection to FG on the soldered side of PCB is not approved as protective earthing by safety standards. (*Please refer to the outline drawing regarding a heatsink with mounting holes.)
- Be recommended to connect the FG portion of solder face of PCB to customer's metal system body with metal parts such as metal spacers to reduce noise.

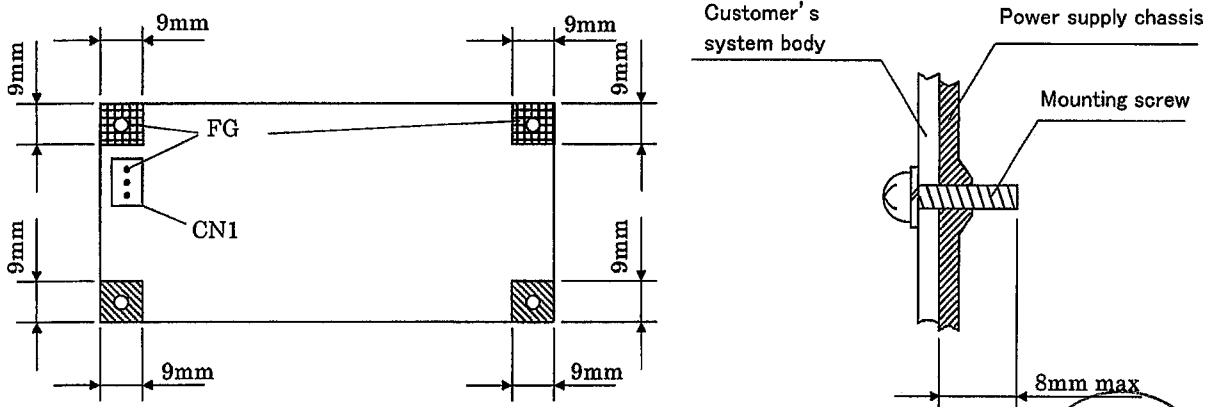







Note



Drawn by	Yodo	Checked by	Yamada	Approved by	Yamamoto	Model:	mUZP-150-**-**E*	Drawing No.	3382-01-4-520
									9/10

Precautions before use

1. Grounding  Warning
This unit is designed and produced to meet Class I equipment. Make sure to connect the grounding terminal of the unit to grounding in a proper way for safety.
2. Electric shock  Warning
This unit is designed and produced as built-in equipment and high-voltage part inside. Make sure to securely install in the equipment in a proper way to prevent electric shock. Also, shorting plug (CN2) for RC signal setting is primary circuit components. When the plug is handled, make sure to turn off AC input before the handling of the plug.
3. PCB handling  Caution
In handling, use the edge of the PCB so as not to touch the component sides. Lift the PCB from the equipment with filter pieces in installation. Besides, handle the PCB with care to prevent twisting or bending of the PC board as it has SMT components on it.
4. Output short circuit  Caution
Prevent shorting outputs. When output is shorted, capacitors inside the power supply rapidly discharge leading to fire and/or spark resulting in serious accident. It also shortens the lifetime of the power supply. Also, any failures or a latch stop may occur.
5. Inrush current control circuit  Caution
To prevent inrush current into rectifying capacitors when AC input is turned on, a power thermistor is used. When AC input is turned on before the temperature of the thermistor goes low after turning off, huge inrush current may occur. Make sure to keep 60-second period at least before reclosing of AC input.
6. Output energy  Caution
The output energy of this unit is 240VA or more, and regarded as dangerous. Any operators must not touch the unit. Besides, apply necessary measures to prevent service personnel or service tools to touch accidentally the equipment with this unit installed. Make sure that the output voltage of this unit goes down to the safe level before servicing after the input voltage is turned off.



Drawn by	Yodo	Checked by	Yamada	Approved by	Yamamoto	Model: mUZP-150-**-**E*	Drawing No. 3382-01-4-520 10/10
----------	------	------------	--------	-------------	----------	----------------------------	---------------------------------------

Nipron Co.,Ltd.

