

**Scope**

This specification applies to built-in DC stabilized power supply, UZP-600-A\*\*-\*\*\*\*-\*.  
 In addition, all items in this specification shall be provided at nominal temperature and humidity unless otherwise specified.

**Model Name Coding**

Example : U Z P - 6 0 0 - A 2 4 - J H 0 □ - K  
 ① ② ③ ④ ⑤ ⑥ ⑦ ⑧ ⑨ ⑩

- ① Series Name....."UZ": UZ series
- ② Peak power....."P": Corresponding to Peak power
- ③ Continuous output power....."600": 600W
- ④ Arrester....."A": With Arrester
- ⑤ Output voltage....."24": 24V, "48": 48V
- ⑥ Input / output connector type....."J": Nylon connector, "T": Block terminal
- ⑦ Connector direction....."H": Horizontal, "V": Vertical
- ⑧ Optional function... "0": Without
- ⑨ Modification..... "Blank": Standard, "1-9" or "A-Z": Modification code
- ⑩ Cover....."K": With Cover, "Blank": Without Cover

**General Specification**

Items		Specification		Measurements conditions, etc.	
		Main output			
		24V	48V		
AC Input	Rated Voltage		100-240VAC		Worldwide range
	Voltage Range		85-264VAC		Load factor shall be 90-100% in range of 85-90VAC input Starting voltage: 80V AC ±10V
	Current	At 115VAC	5.8A typ.		At rated output (Natural air cooling)
			7.8A typ.		At rated output (Forced air cooling)
		At 230VAC	2.9A typ.		At rated output (Natural air cooling)
			3.9A typ.		At rated output (Forced air cooling)
	Rated Frequency		50/60 Hz		Frequency range 47-63Hz
	Inrush Current	At 100VAC	18A typ.		Power thermistor system At cold start (25°C)
		At 200VAC	36A typ.		
	Efficiency	At 115VAC	93% typ.		The main output is at rated load. The standby output is at no load.
At 230VAC		95% typ.			
Power Factor	At 115VAC	98% typ.		At rated output (Natural air cooling)	
	At 230VAC	96% typ.			

Note:

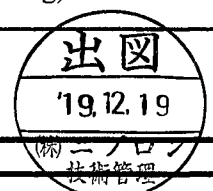

Drawn by	Checked by	Approved by	Model:	Drawing No.
Yodo	Yamada	Yamamoto	UZP-600-A**-****-*	3626-01-4-520

Items		Specification		Measurements conditions, etc.
		Main output		
		24V	48V	
Environment	Operating Temp.	Natural Air Cooling	-20 to 70°C (Open frame)	Refer to "Output derating specification".
			-20 to 60°C (With cover)	
		Forced Air Cooling	-20 to 70°C (Open frame)	Refer to "Output derating specification".
			-20 to 70°C (With cover)	
	Operating Humidity	20 to 90%RH		
	Storage Temp. / Humidity	-20 to 85°C / 10 to 95%RH		There shall no condensation
	Vibration	To endure the vibration acceleration of 2G with vibration frequency of 10 to 55Hz for 10 sweep cycles in each X, Y, Z direction.		Follow JIS-C-60068-2-6 At no operation
Surface Dropping	Left one bottom edge of the unit 50mm high with the opposite edge placed on the test bench, and let it fall. Repeat 3 times for each of four bottom edges, and no malfunction shall be observed.		Follow JIS-C-60068-2-31 At no operation	
Insulation	Dielectric Strength	1.5kVAC/1min. between input and main output/standby output/RC/AC FAIL (*1)		Cut-off current 10mA
		1.5kVAC/1min. between input and FG		Cut-off current 10mA
		500VAC/1min. between main output /standby output/RC/AC FAIL and FG.		Cut-off current 100mA
		500VAC/1min. between each main output and standby output/RC/AC FAIL		
	Insulation Resistance	50MΩ min. between each input/output/RC/AC FAIL/FG		At 500 VDC
	Leakage Current	0.06mA typ. (at100VAC), 0.12mA typ. (at200VAC)		
Others	Electrostatic discharge	IEC61000-4-2 test level 3 compliant (Contact discharge: ±6kV, 10 times)		Apply to FG and case. There shall be no malfunction, nor failure.
	Fast transient burst	IEC61000-4-4 test level 3 compliant		There shall be no malfunction, nor failure.
	Impulse voltage immunity	IEC-61000-4-5 (Installation environment 4 min.) compliant; apply 5 times each of Common mode ±4kV and Normal mode ±2kV		There shall be no malfunction, nor failure. With arrester.
	Conducted emission	VCCI/FCC/CISPR32/EN55032 Class B compliant		At rated Input and output (Natural air cooling)
	Harmonic current regulations	IEC61000-3-2 (edition 2.1) class D, EN61000-3-2 (A14) class D compliant.		At rated input and continuous rating output
	Safety Standard	UL62368,(c-UL) certification		
		CE marking adapted PSE (Ordinance item 2) compliant		
	Cooling system	Natural air cooling		
	Dimensions and Weight	127×44×228.6 (W×H×D) / 1300g typ.		With cover
127×51×228.6 (W×H×D) / 1450g typ.				
Warranty	Three years after delivery: if any defects belong to us, the defective unit shall be repaired or replaced at our cost.		Except for errors caused by operation not specified in this specification.	

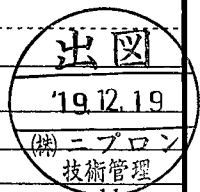

Note:  
 \*1 The between input and main output/RC/AC\_FAIL has a tolerance of AC 3kV/1 min., but there is an arrester between the input and FG. Because it is installed, the above specifications.

Drawn by	Checked by	Approved by	Model:	Drawing No.
Yodo	Yamada	Yamamoto	UZP-600-A**-*****_*	3626-01-4-520

Output Specification							
Items		Specification				Measurement conditions, etc.	
		Main output		Stand-by output			
		24V	48V	12VSB *2			
Output Rating	Rated Voltage		24V	48V	12V		
	Continuous rating 1 (natural air cooling)	Current	25A	12.5A	0.42A	At rated input Refer to "Output derating specification"	
		Power	600W	600W	5W		
	Continuous rating 2 (forced air cooling)	Current	33.4A	16.7A	0.42A		
		Power	801.6W	801.6W	5W		
	Peak rating (5 seconds or less)	Current	50A	25A	0.42A	Refer to "Peak output specification" Natural air cooling and forced air cooling.	
Power		1200W	1200W	5W			
Output Characteristics	Factory setting		24V±2%	48V±2%	12V±5%	At continuous rating output 1	
	Adjustable voltage range		24V -2%,+10%	48V -2%,+10%	Fixed		
	Static input regulation		94mV max.	192mV max.	47mV max.		
	Static load regulation	Rated load	150mV max.	300mV max.	75mV max.		
		Peak load	250mV max.	500mV max.			
	Temperature regulation	0 to 70°C	0.02%/°C max.				
		-20 to 0°C	0.04%/°C max.				
	Ripple voltage	0 to 70°C	130mVp-p max.	260mVp-p max.	120mVp-p max.	Connect 150mm max. lead wire to output connectors, and then connect a 10µF electrolytic capacitor with a 0.1µF ceramic capacitor in parallel to the other ends of the wires to measure by an oscilloscope with 100MHz frequency band. (*3)	
		-20 to 0°C	175mVp-p max.	350mVp-p max.	160mVp-p max.		
	Spike voltage	0 to 70°C	150mVp-p max.	300mVp-p max.	150mVp-p max.		
-20 to 0°C		200mVp-p max.	400mVp-p max.	180mVp-p max.			
Protection Circuit	Over current protection	OCP point	101% min. of peak rated current		0.44Amin.		
		Method	Blocking oscillation		Blocking oscillation		
		Recovery	Automatic recovery		Automatic recovery		
	Over voltage protection	OVP point	28.0-33.0V	56.2-63.0V	—	—	
		Method	Output shutdown (latch lock)		—	—	
		Recovery	Reclosing of AC input		—	—	

Note:

\*2 Standby output is interlocked with AC input.

\*3 The ripple and spike voltage at 200W or less output shall be 400mV/500mV max.



Drawn by	Checked by	Approved by	Model:	Drawing No.
Yodo	Yamada	Yamamoto	UZP-600-A**_****_*	3626-01-4-520
				3/11

Signal Input/Output specification																
Items	Specification	Signal circuit diagram														
Input signal	<p>Output ON/OFF control signal (RC signal)</p> <p><u>Operating mode</u></p> <table border="1"> <tr> <td>Between +RC and -RC</td> <td>CH1 output</td> </tr> <tr> <td>SW ON(4.5V min.)</td> <td>ON</td> </tr> <tr> <td>SW OFF(0.8V max.)</td> <td>OFF</td> </tr> </table> <p><u>External power supply and Load-limiting resistor</u></p> <table border="1"> <tr> <td>External power supply:E</td> <td>Load-limiting resistor : R</td> </tr> <tr> <td>4.5 to 12.5Vdc</td> <td>Not required</td> </tr> <tr> <td>12.5 to 30Vdc</td> <td>1.5kΩ</td> </tr> <tr> <td>30 to 48Vdc</td> <td>8.2kΩ</td> </tr> </table> <p><u>Shorting Plug</u>                      With shorting plug (CN2) connected, output starts up when AC input is applied regardless of RC signal.                      To control Start/Stop of output by RC signal, uncap shorting plug of CN2.</p> <p><b>Note:</b> Shorting plug (CN2) is primary circuit components. Make sure to operate the plug after the AC input is turned off.</p>	Between +RC and -RC	CH1 output	SW ON(4.5V min.)	ON	SW OFF(0.8V max.)	OFF	External power supply:E	Load-limiting resistor : R	4.5 to 12.5Vdc	Not required	12.5 to 30Vdc	1.5kΩ	30 to 48Vdc	8.2kΩ	<p><u>Connection example: using external power supply</u></p> <p><u>Connection example: using standby output</u></p> <p>※Output start-up with SW on</p>
	Between +RC and -RC	CH1 output														
SW ON(4.5V min.)	ON															
SW OFF(0.8V max.)	OFF															
External power supply:E	Load-limiting resistor : R															
4.5 to 12.5Vdc	Not required															
12.5 to 30Vdc	1.5kΩ															
30 to 48Vdc	8.2kΩ															
Remote Sensing signal (RS signal)	<p>Input terminal for detection of output voltage.                      Connecting RS signal to positive side of devices, it shall compensate line-drop at positive side such as output cable.</p>															
Output signal	<p>Blackout detection signal (AC_FAIL)</p> <p>The signal goes "OPEN" at low AC input voltage and power failure detection.                      Detection voltage: 80 V AC typ.                      Detection delay time: 20 to 50ms after AC input failure.</p>	<p><u>Circuit</u></p>														
Note:																



Drawn by	Checked by	Approved by	Model:	Drawing No.
Yodo	Yamada	Yamamoto	UZP-600-A**-****-*	3626-01-4-520
				4/11

●Sequence Timing diagram (Without Capacitor Package)

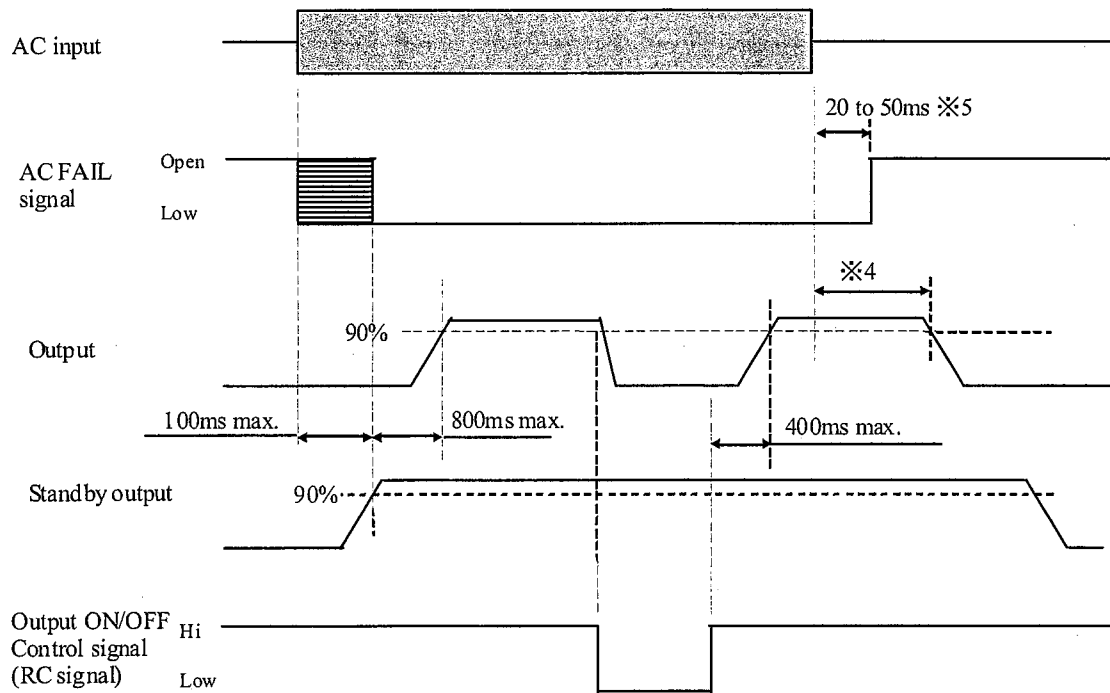

 Undefined area     
 \*4 : Refer to the graph below for the retention time.  
 \*5 : When output power is under 10% and input voltage is higher than 150VAC, it shall be 150mS max.

\*4. Retention time(Representative value)

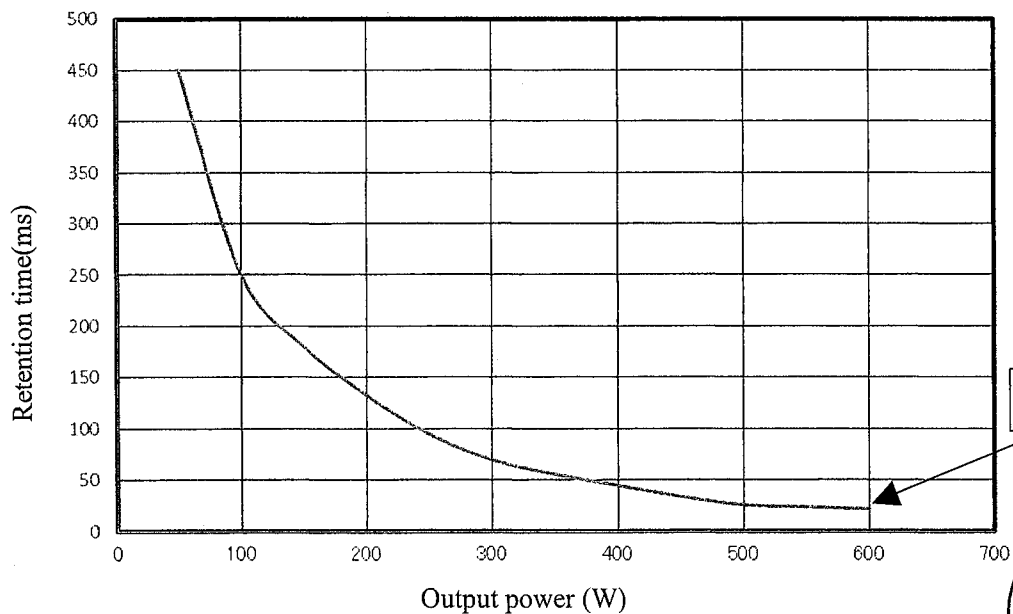

20ms typ.

出図  
19.12.19  
(株)ニプロン  
技術管理

Drawn by	Checked by	Approved by	Model:	Drawing No.
Yodo	Yamada	Yamamoto	UZP-600-A**_****_*	3626-01-4-520

**●Peak output specification**

Peak output current shall meet the conditions below.

- Duty ratio of peak current shall be 30% or less
- Energized period of peak current shall be 5 seconds or less.
- The value resulting from the formula below shall not exceed the continuous rated current, I<sub>o</sub>, after derating specified in “Output derating” item.

$$\sqrt{((I_p^2 \times D) + (I_m^2 \times (1 - D)))} \leq I_o$$

I<sub>p</sub>=Peak current value  
 I<sub>m</sub>=Min. current value  
 D=Duty ratio, t/T  
 t=Pulse width of peak current  
 T=Cycle  
 I<sub>o</sub>=Continuous rated current specified in  
 “Output derating” item

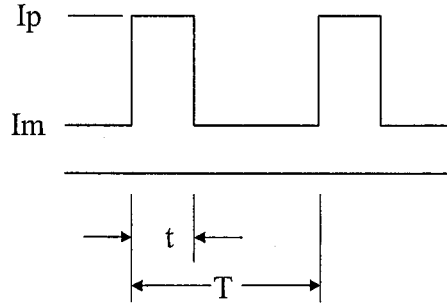

**●Peak output derating for output voltage**

Reduce the peak power according to the derating diagram below according to the output voltage setting value.

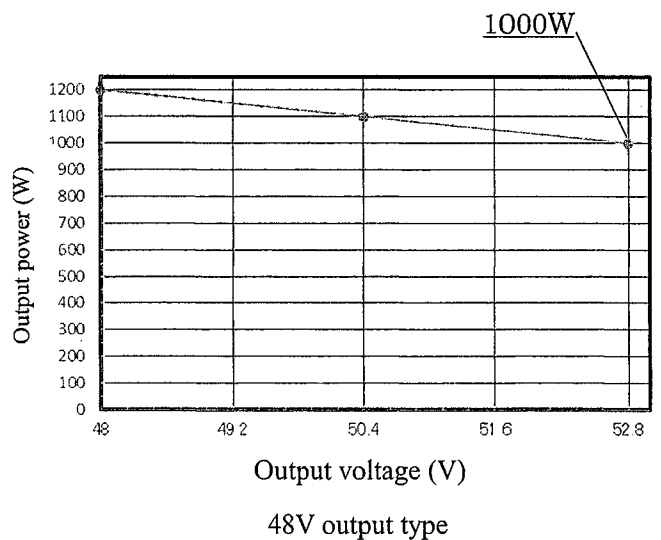
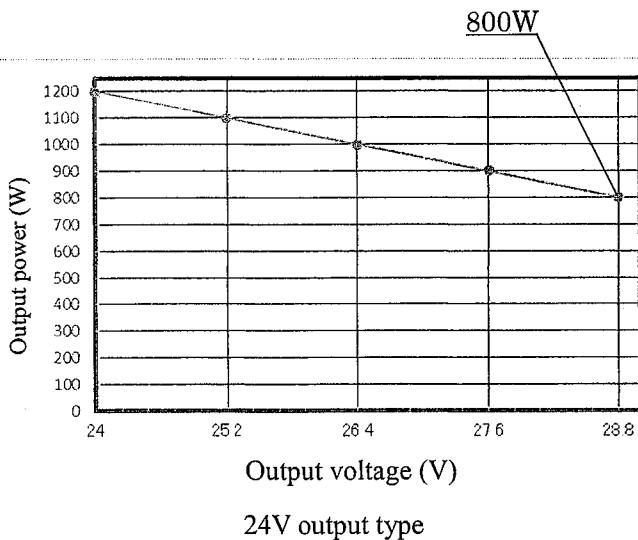

Drawn by	Checked by	Approved by	Model:	Drawing No.
Yodo	Yamada	Yamamoto	UZP-600-A**_****_*	3626-01-4-520

**●Output derating based on ambient temperature, installation direction and cooling condition**

The following figure shows the required output derating diagram with the mounting holes (4 locations) on the bottom of the power supply installed on a 1.6mm thick steel plate.  
 Reduce the output power according to the derating diagram below according to the ambient temperature of the power supply.  
 Also, forced air cooling condition in the diagram shall be provided that the air flow of 2m/s passes through the CN1 as shown below.

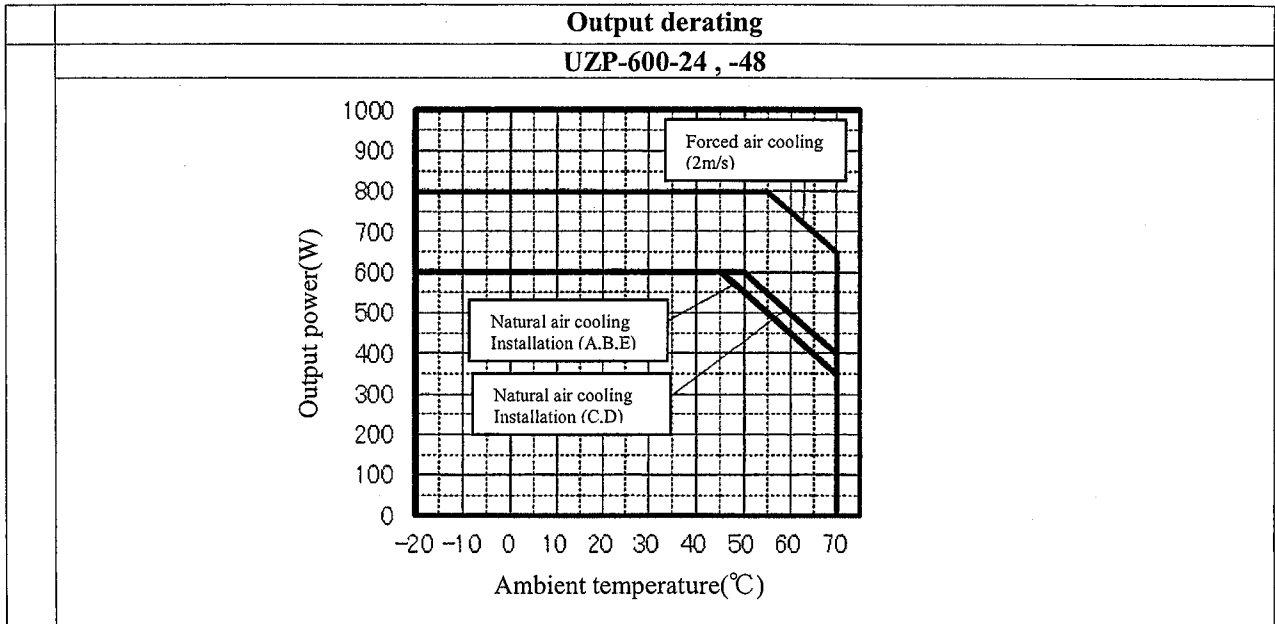
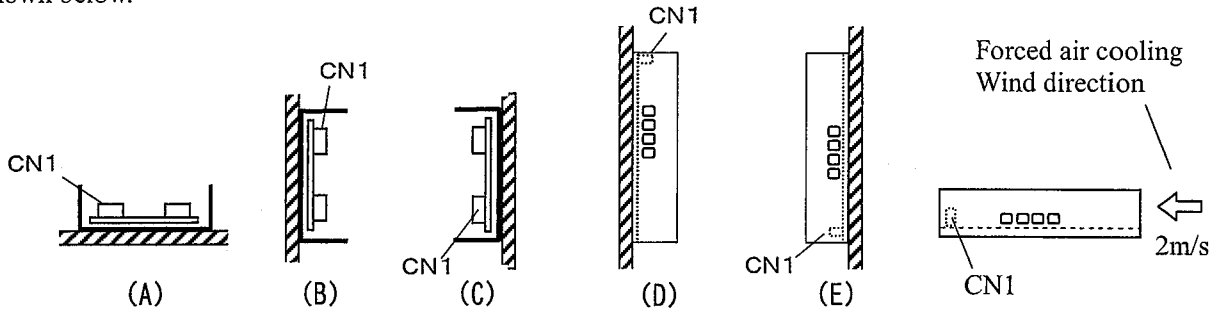

Drawn by	Checked by	Approved by	Model:	Drawing No.
Yodo	Yamada	Yamamoto	UZP-600-A**-*****-*	3626-01-4-520

**●Output derating vs. Input voltage**

When input voltage is 90VAC or lower, follow the derating diagram below to reduce the continuous rated current and power.

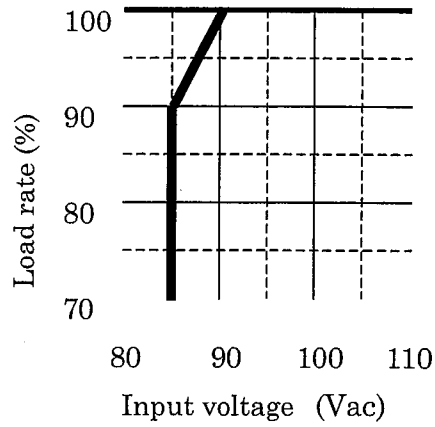

Note:



Drawn by	Checked by	Approved by	Model:	Drawing No.
Yodo	Yamada	Yamamoto	UZP-600-A**-*****-*	3626-01-4-520



●Circuit block diagram

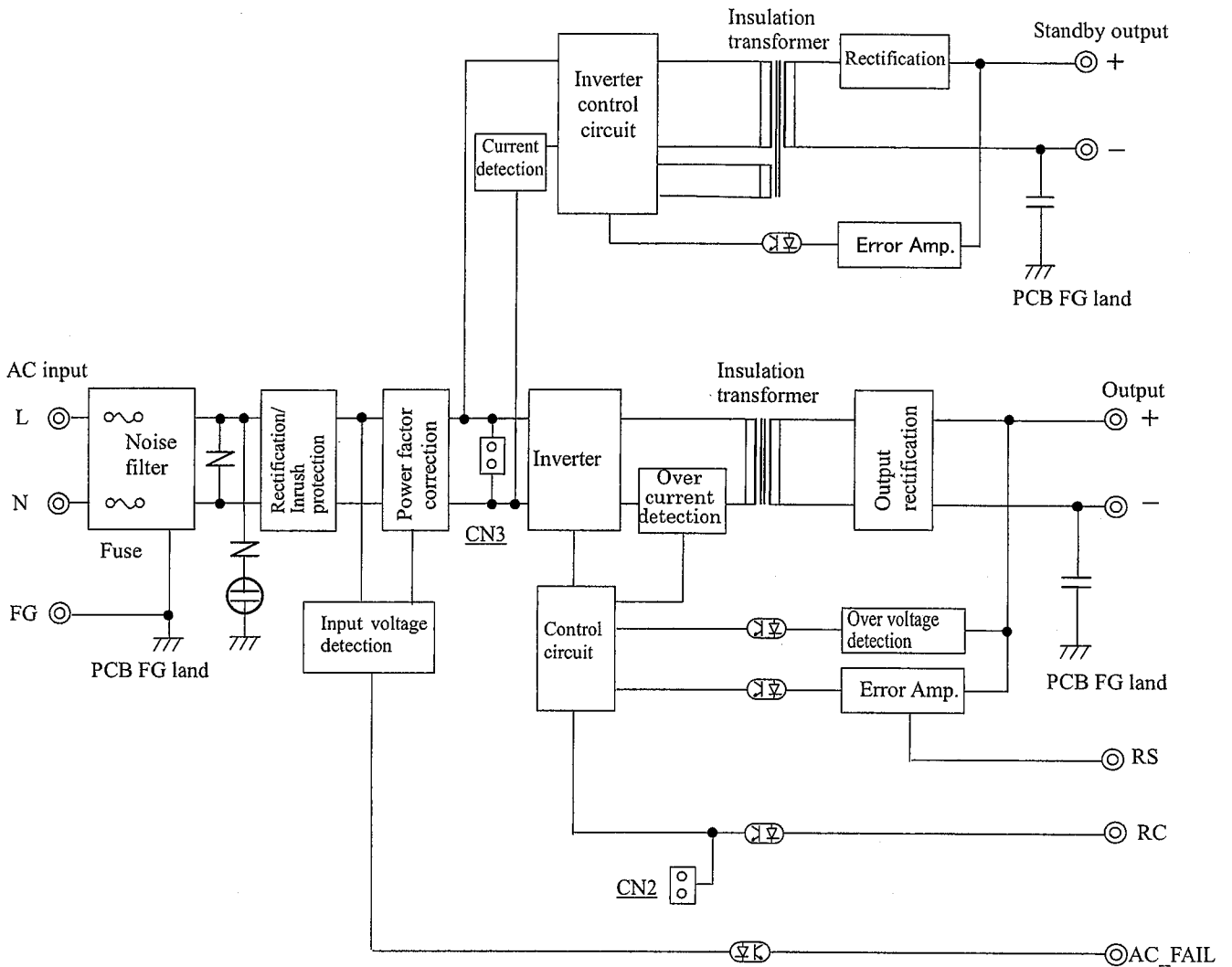

Note:



Drawn by	Checked by	Approved by	Model:	Drawing No.
Yodo	Yamada	Yamamoto	UZP-600-A**-*****-*	3626-01-4-520

**●Power supply installation and mounting screws**

- To meet the standard of insulation and dielectric withstanding, install the power supply to keep the dimensions, d1, and d2, shown in the drawings below.
- Install the power supply so that natural air convection and air ventilation are expected to keep the temperature rise around the power supply low.

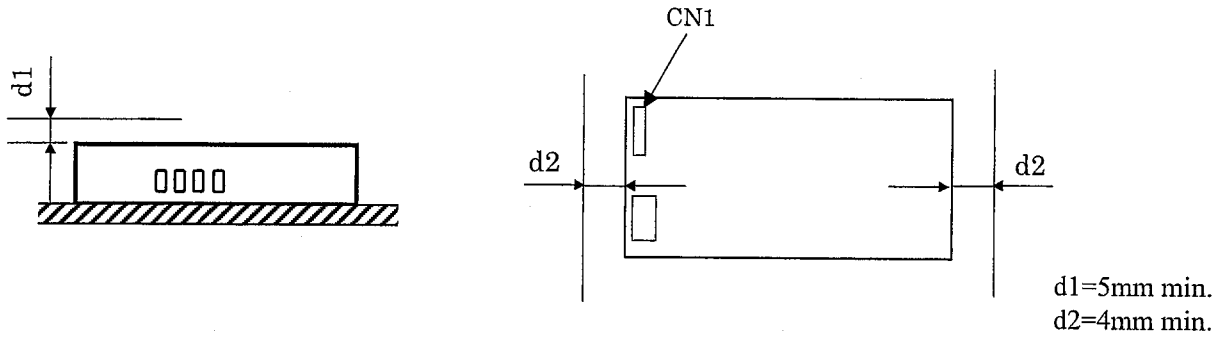







- In terms of mounting dimensions and screws for power supply, please refer to the outline drawings.

Note



Drawn by	Checked by	Approved by	Model:	Drawing No.
Yodo	Yamada	Yamamoto	UZP-600-A**-*****-*	3626-01-4-520

**●Precautions before use**

1. Grounding  Warning  
This unit is designed and produced to meet Class 1 equipment. Make sure to connect the grounding terminal of the unit to grounding in a proper way for safety.
2. Electric shock  Warning  
This unit is designed and produced as built-in equipment and has high-voltage part inside. Make sure to securely install in the equipment in a proper way to prevent electric shock. Also, shorting plug (CN2) for RC signal setting is primary circuit components. When the plug is handled, make sure to turn off AC input before the handling of the plug.
3. PCB handling  Caution  
In handling, use the edge of the PCB so as not to touch the component sides. Lift the PCB from the equipment with filter pieces in installation. Besides, handle the PCB with care to prevent twisting or bending of the PC board as it has SMT components on it.
4. Output short circuit  Caution  
Prevent shorting outputs.  
When output is shorted, capacitors inside the power supply rapidly discharge leading to fire and/or spark resulting in serious accident. It also shortens the lifetime of the power supply.
5. Inrush current control circuit  Caution  
To prevent inrush current into rectifying capacitors when AC input is turned on, a power thermistor is used. When AC input is turned on before the temperature of the thermistor goes low after turning off, huge inrush current may occur. Make sure to keep 60-second period at least before reclosing of AC input.
6. Output energy  Caution  
The output energy of this unit is 240VA or more and regarded as dangerous.  
Any operators must not touch the unit. Besides, apply necessary measures to prevent service personnel or service tools to touch accidentally the equipment with this unit installed. Make sure that the input/output voltage of this unit goes down to the safe level before servicing after the input voltage is turned off.



Drawn by	Checked by	Approved by	Model:	Drawing No.
Yodo	Yamada	Yamamoto	UZP-600-A**-*****-*	3626-01-4-520
				11/11

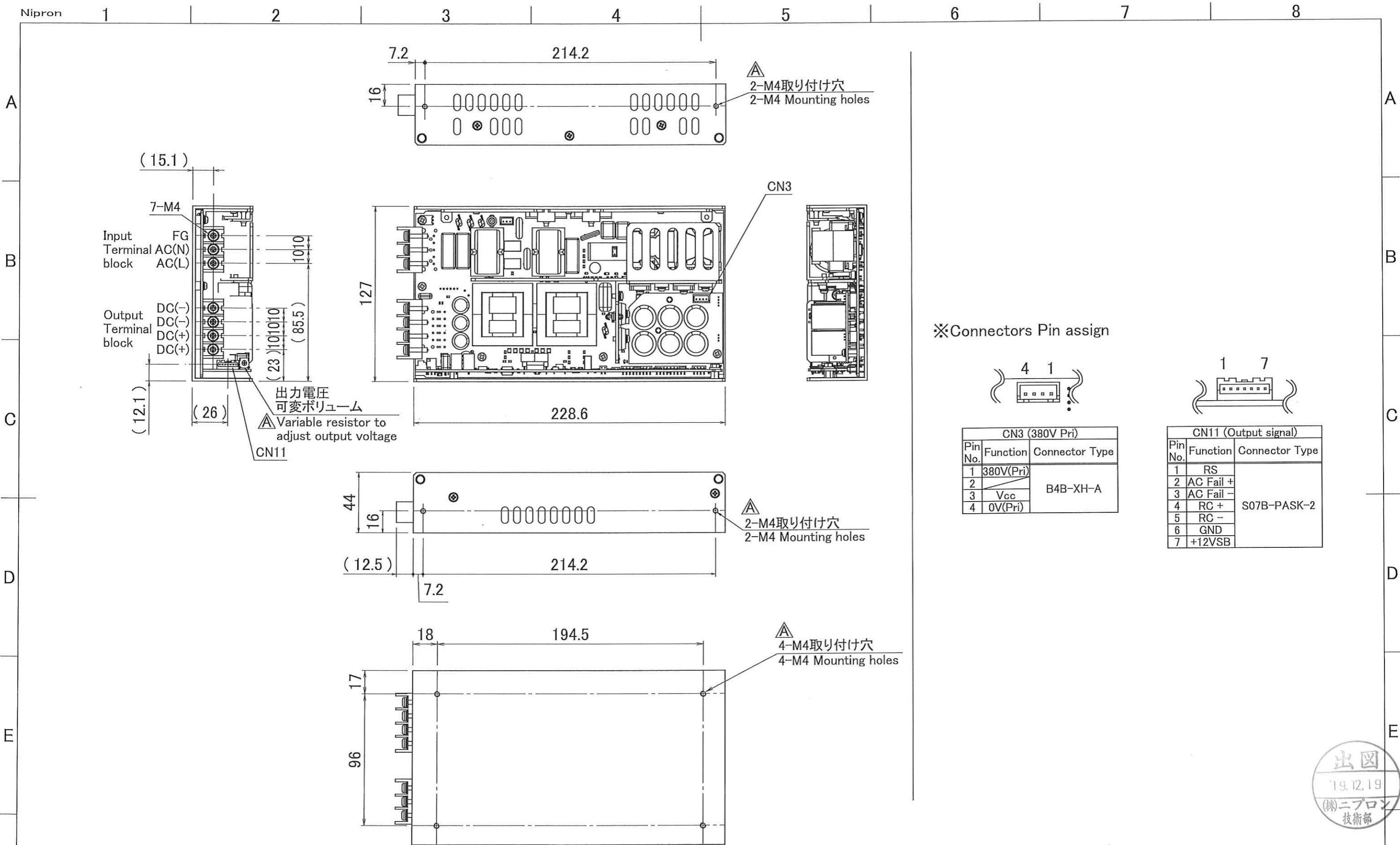

注1: 指示なき寸法公差は ±1mm とする  
 注2: 取り付けビスの電源内部長さは 4mm MAX.  
 注3: 取付部の寸法公差は ±0.5mm とする  
 Note 1: Design tolerance of dimensions is ±1mm.  
 Note 2: The screw depth of penetration into power supply is 4mm MAX.  
 Note 3: Design tolerance of mounting dimensions is ± 0.5mm.



A版 △×4:2019.12.06 奥平(麻) I-311145(英文追記)

DRAWN BY	CHECKED BY	CHECKED BY	APPROVED BY	SCALE	MATERIALS	TITLE
				UNITS		
ISSUED				3RD ANGLE PROJECTION	FINISH	DRAWING NO.
2019.07.09						3626-05-3-050 [A]